



Model of Discharge Lamp Sodium With High Pressure

Larab Moulay, Farid Miloua and Ayad Ahmed Nour El Islam

EasyChair preprints are intended for rapid dissemination of research results and are integrated with the rest of EasyChair.

November 18, 2019

Model of Discharge Lamp Sodium With High Pressure

LARAB Moulay

Laboratoire APELEC ,
University Djillali Liabes
of Sidi Bel Abbes,

Sidi Bel Abbès 22000, Algeria

E-mail: larabmoula@gmail.com

FARID MILOUA

Laboratoire APELEC ,
University Djillali Liabes
of Sidi Bel Abbes,

Sidi Bel Abbès 22000, Algeria

AYAD AHMED NOUR EL ISLAM

Laboratoire APELEC ,
University Djillali Liabes
of Sidi Bel Abbes,

Sidi Bel Abbès 22000, Algeria

Abstract— *The aim had by this study it is the representation of the variables of exits of a gas-discharge lamp sodium high pressure, by simple models, easily exploitable. Various approaches all, based on the parameters of constructions of the lamp, are used to represent it, the theoretical modelling of the electric discharge, based on work of Mrs Cassie and Mayer A to start from these models of references, a combination of their respective advantages succeeded twinned one, which we studied under Matlab-simulink environment.*

Keywords— *Discharge; Lamp sodium; High pressure*

I. INTRODUCTION

The gas-discharge lamp sodium high pressure are applied largely in road lighting and the tunnel because of their high effectiveness and long lifespan. Like the majority of the gas-discharge lamps, they also have negative differential resistance to work. As a current consequence of the components while limiting called ballasts are connected to the lamp in series. Put aside the inductive traditional ballasts, broader application finds what is called electronic ballasts. The latter to offer higher outputs of brightness, higher index of brightness and exploitation more lifespan[1].

Some of the ballasts of gradation allow lamp of what leads to the energy saving. In order to design an electronic ballast a simulation of co-operation between the ballast and the lamp sodium high pressure is initially necessary.

The model of brightness source which must describe proportioned the behavior of the electric parameters of the flow of brightness is also necessary. It is very difficult and uncomfortable for the engineer, to analyze the physicochemical processes in the tube with discharge when designing electronic ballast and thus to model the lamp as a system with distributed parameters.

Paper represents a model of lamp sodium high pressure like a pole including two with concentrated parameters, the variables which are in progress basin which runs lamp and the terminal voltage of the lamp. Luminous flow is expressed by the electric parameters of the lamp [3] [4].

II. MODEL OF CASSIE - MAYR

In this section, the Cassie model - Mayr will be

explained. This model was already implemented, but certain work was carried out on the parameters of the model. First of all, a short reminder of the model is given, then the implementation, parameters of the model and the results are presented. Lastly, certain conclusions are made[4] [6], [7], [8].

A. Equations of the model:

The power of arc can be calculated by the following equation[4]:

$$P = v \cdot i = P_{per} + \frac{dQ}{dt} \quad (1)$$

Where:

P:provided power.

v:is the tension of arc.

i:is current electrode.

P_{per} :is the dissipated power of arc (is the power of lost or thermal attenuation).

Q:is the quantity of heat of stored energy.

$\frac{dQ}{dt}$:is the variation (change) of the quantity in heat Q according to time.

If we suppose that the conductivity of arc G, it is only according to heat Q of energy stored in the arc at a certain time T, then we can write the conductivity of arc according to time by[3]:

$$G(t) = Fct[Q(t)] = \frac{i(t)}{v(t)} = \frac{1}{R(t)} \quad (2)$$

B. The model of Mr CASSIE:

Cassie considers a simple model of arc with a constant temperature of arc By multiplying the two sides of the equation with $\frac{1}{G}$, According to equation[4] :

$$\frac{dG}{dt} = \frac{p_0}{v_0^2 Q_0} (Gv^2 - Gv_0^2) \quad (3)$$

$$\frac{1}{G} \frac{dG}{dt} = \frac{1}{\theta} \left(\frac{v^2}{v_0^2} - 1 \right) \quad (4)$$

The equation of Cassie based on the current of arc which is obtained :

$$\frac{1}{G} \frac{dG}{dt} = \frac{1}{\theta_c} \left(\frac{i^2}{G^2 v_0^2} - 1 \right) \quad (5)$$

The final expression obtained and that the tension is constant $V_0^2 = E_0^2 = \text{constante}$, where the index 'c' represents the model of Cassie:

E_0 :tension of arc at the boundaries of the discharge (with constant current).

$$\frac{dG_c}{dt} = \frac{1}{\theta_c} \left(\frac{i \cdot v}{E_0^2} - G_c \right) \quad (6)$$

C. The model of O. Mayr:

For the capacity of constant specific heat, $Q = \text{const}T$, where T is the temperature, σ electric conductivity, can be expressed by $\sigma = \text{const}T$, conductivity is taken as approximation of the expression of Saha for a gas balance and a certain gas. It is given by the following equation [3] [4]:

$$\text{Ln} \frac{x^2}{1-x^2} \cdot \text{Pr} = -\frac{U}{aT} + b \cdot \text{Ln}(T) - C \quad (7)$$

With:

x:degré of ionization of this gas

Pr :total pressure

U:heat of the dissociation of this gas

T:absolute:température in Kelvin

a, b, c:they are constants.

The final expression of Mayr is as follows:

$$\frac{dG_m}{dt} = \frac{1}{\theta_m} \left(\frac{i^2}{P_0} - G_m \right) \quad (8)$$

And the equation original of Mayr transformed with:

$$G_m = \frac{i^2}{P_0} - \theta \frac{dG_m}{dt} \quad (9)$$

D. Mathematical model of the lamp sodium high pressure:

To define the combined model of cassie-Mayr we will make the acquired characteristic of the two conductance to have the general conductivity given by the following equation[3] [4]:

$$G = G_m + G_c \quad (10)$$

$$\frac{d\left(\frac{1}{U_d}\right)}{dt} = \frac{1}{\theta_{u_d}} \left(\frac{U_d^2}{U_{pk}^2} + \frac{U_d I}{P_0} - 1 \right) + \frac{g_0}{\theta} \quad (11)$$

The quantity of g_0 is conductivity environment.

U_d :is the tension on the arc of light of the lamp.

U_{pk} :is a parameter, by which you configured the tension of starting.

$$u = u_d + u_a \quad (12)$$

u:is the tension fall on the lamp.

u_a :fall of tension for the zones cathode and the anode.

$$\frac{1}{U_a} = \frac{1}{U_d(\alpha|I|^{n+\beta})} + g_0 \quad (13)$$

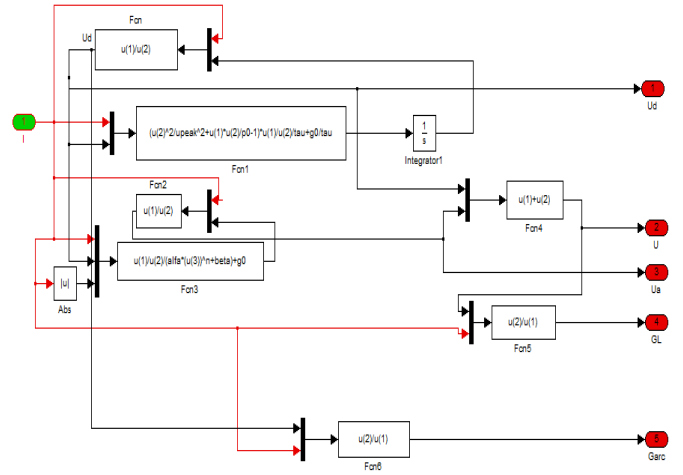

Fig. 1. Universal simulation scheme of a discharge lamp[6], [7], [8].

E. Model of a magnetic ballast:

The ballast is represented by ideal resistance R and inductance L. L' impedance of the reel with less ferromagnetic loss is given by[2], [4],[5]:

$$Z_{ball} = R_{ball} + jX_{ball} \quad (14)$$

From where the reactance of ballast X_{ball} is defined as follows:

$$X_{ball} = \omega X_{ball} \quad (15)$$

$$\omega = \frac{2\pi}{T} = 2\pi f \quad (16)$$

$$u_{ball} = u - u_{lamp} \quad (17)$$

The magnetic ballast is described by the simple linear model, with two parameters R_{ball} and L_{ball} .

III. BEFORE YOU SIMULATION RESULTS AND DISCUSSION

A. Characteristics of the gas-discharge lamp sodium (SHP):

Figure I presents the forms of wave of tension and current of a lamp Sodium 250W supplied with a conventional ferromagnetic ballast functioning at 50Hz [2],[4],[5].

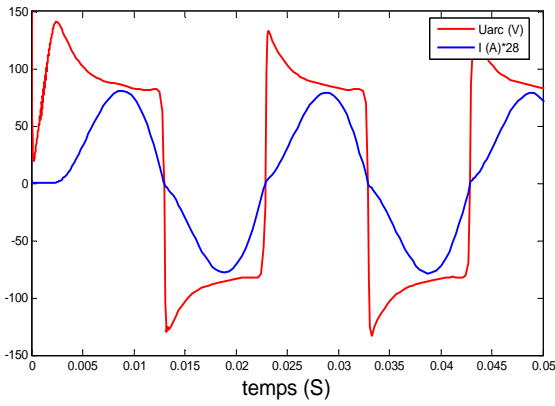

Fig. II (a): comparative Tension and current(I(A)*28)

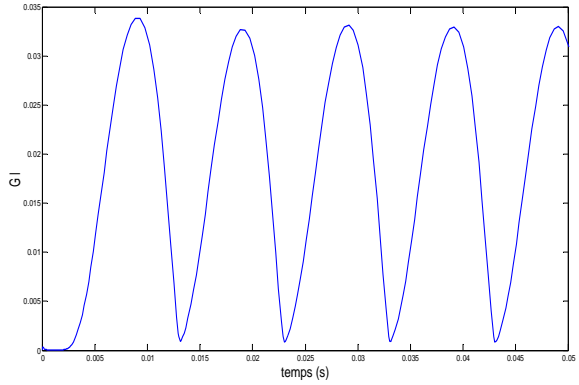

Fig. II (e) Conductivity

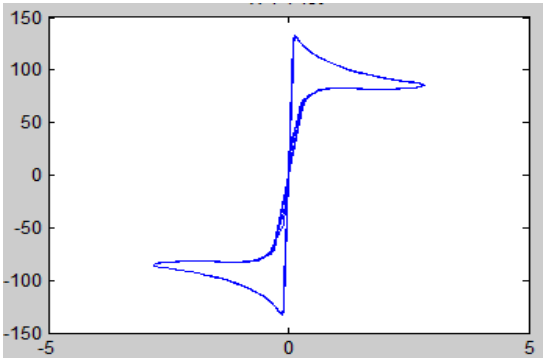

Fig. II (b): Caractéristique Tension/ current 250 W, $f= 50$ Hz

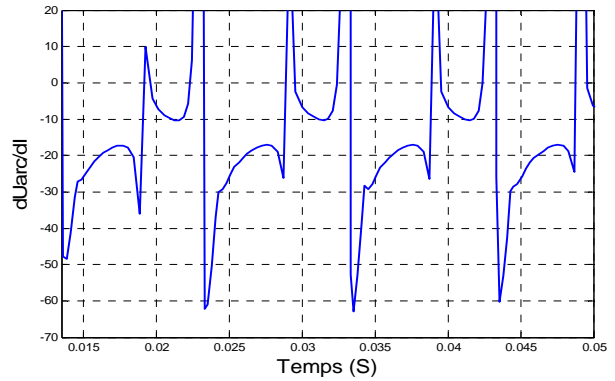

Fig. II (f): the resistance of arc For a frequency 50Hz

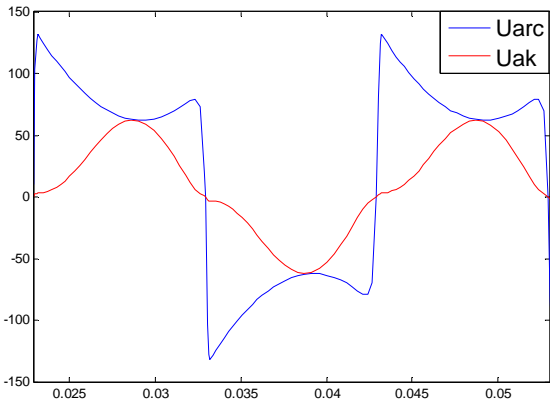

Fig. II (c) comparative Tension Uarc et Uak , (SHP 250 W)

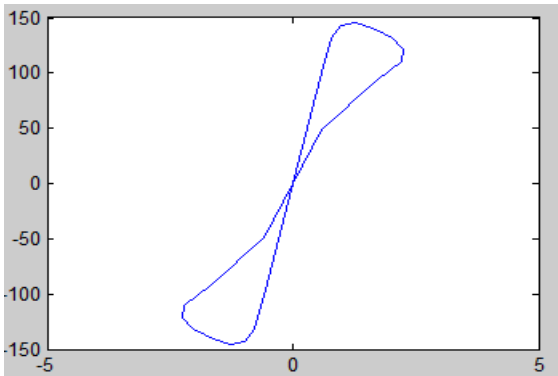

Fig. II (d) Caractéristique Tension/ current,250 W, $f= 500$ Hz

In addition, as we can note it, for a sinusoidal current of food, the tension of the lamp although it is in phase with the current, presents a rather complex form [5],[2],[4].

This form, as the graphic construction of the figure fig. (b) shows it, is imposed by the characteristic tension current of the discharge which is strongly non-linear at this frequency. We can also find this type of form of wave . in other lamps, such as the mercury lamp, for operation low frequency. By looking at the form of the tension, we note that it can be approximated by a crenel.

In addition, we know that a crenel breaks up into a Fourier series which contains only odd terms of the frequency of fundamental (frequency of the network for our case).We can thus include/understand that the lamp thanks to its non-linearity is responsible for the generation of harmonics located at 150Hz, 250Hz, 350Hz, etc that in the absence of filtering, they will be injected into electrical supply network of city (in particular in the neutral) and will degrade the quality of the energy. obviously, the ferromagnetic ballast cannot prevent this "pollution"[2], [4],[5].

While returning to the form of the tension of the lamp one notes also the presence of a maximum of amplitude which corresponds in the passing of the current by zero: it is the "peak of restarting".

This phenomenon is explained by the change of the temperature of the discharge related to the conductance of the lamp. Indeed, this passage by zero involves the reduction in the temperature and by electric conductivity in plasma and this fact the equivalent resistance of the lamp increases.

When the current reaches a sufficient value, the temperature as well as conductivity increase. The tension becomes constant and preserves its amplitude. To complicate the situation, as shows it the fig. (b), a phenomenon of hysteresis appears in the dynamic U-i characteristic. According to the literature, this phenomenon of hysteresis is related to the space charge on the level of cathode. These explanations remain reasonable when the lamp operation in low frequency [2], [4],[5].

IV. CONCLUSION

Proceeded of also of let us have to Us an environment under Matlab, lamp of simulation of one of in of arc of discharge of electric of theoretical representation of the conductivity of one of one of we based. L' obtained results of pour waves of forms of, it of the tension and of arc running of, like that of the characteristic running - tension.

REFERENCES

- [1]. G. Lister, J. E. Lawler, W. P. Lapatovich, and V. A. Godyak.. The physics of discharge lamps. Reviews of modern physics, 76:541–598, April 2004 M. Etique : "Introduction au logiciel Matlab, cours bloc", eivd, 2001.1.
- [2]. G. Zissis. Light Sources: what evolution for the future? Sources de lumière artificielle, Quel avenir? In Proceedings ECMS 2005, Electronique, Contrôle, Modélisation, Mesure et Signal. Université Paul Sabatier, Toulouse, Mai 17–20 2005.
- [3]. Florin Ciprian Argatu¹, Costin Cepișcă². Modeling Dynamic High Intensity Dischargelamp Characteristics, u.p.b. sci. bull., series c, vol. 72, iss. 3, 2010.
- [4]. J. Gabriel P.Cantero. Modelado Del Horno De Arco Eléctrico Para Estudios Relacionados Con La Calidad De La Energía Eléctrica ,Instituto Politécnico Nacional, México, D.F. Junio 2007.
- [5]. Jan Koprnický. Electric Conductivity Model Of Discharge Lamps ,University Paul Sabatier Toulouse iii, 2007.
- [6]. W.J. Palm iii . Introduction to Matlab For Engineers , Wcb McGraw-Hill, 1998.
- [7]. M. Etique . Introduction Au Logiciel Matlab,Cours Bloc, Eivd, 2001.1.
- [8]. D.M. Etter. Engineering Problem Solving With Matlab, Prentice Hall, (1993 ,27, 30).